

## CMIP3C82W-28MDA

### 8 MP Full Color Fixed Turret Network Camera



The camera provides 24/7 vivid colorful images with F1.0 advanced lenses and high performance sensors. F1.0 super-aperture collects more light to produce brighter images. Advanced sensor technology can vastly improve the utilization of available light.

- High quality imaging with 8 MP resolution
- Efficient H.265+ compression technology
- Clear imaging against strong backlight due to 130 dB WDR technology
- Built-in microphone for real-time audio security
- Focus on human and vehicle targets classification based on deep learning
- 24/7 colorful imaging
- Water and dust resistant (IP67)



## ▪ Specification

Camera	
Image Sensor	1/1.2" Progressive Scan CMOS
Max. Resolution	3840 × 2160
Min. Illumination	Color : 0.0005 Lux @ (F1.0, AGC ON)
Shutter Speed	1/3 s to 1/100,000 s
Day & Night	24/7 Color imaging
Angle Adjustment	Pan: 0° to 360°, tilt: 0° to 75°, rotate: 0° to 360°
Lens	
Lens Type	Fixed focal lens, 2.8 mm optional
Focal Length & FOV	2.8 mm, horizontal FOV 102°, vertical FOV 52°, diagonal FOV 124°
Lens Mount	M16
Iris Type	Fixed
Aperture	F1.0
Depth of Field	2.8 mm: 3.1 m to ∞
DORI	
DORI	2.8 mm: D: 96 m, O: 38 m, R: 19 m, I: 9 m
Illuminator	
Supplement Light Type	White Light
Supplement Light Range	Up to 98ft(30 m)
Smart Supplement Light	Yes
Video	
Main Stream	50 Hz: 25 fps (3840 × 2160, 3200 × 1800 , 2688 × 1520, 1920 × 1080, 1280 × 720) 60 Hz: 24 fps (3840 × 2160) 30 fps (3200 × 1800 , 2688 × 1520, 1920 × 1080, 1280 × 720)
Sub-Stream	50 Hz: 25 fps (640 × 480, 640 × 360) 60 Hz: 30 fps (640 × 480, 640 × 360)
Third Stream	50 Hz: 10 fps (1920 × 1080, 1280 × 720, 640 × 480, 640 × 360) 60 Hz: 10 fps (1920 × 1080, 1280 × 720, 640 × 480, 640 × 360)
Video Compression	Main stream: H.265/H.264/H.264+/H.265+ Sub-stream: H.265/H.264/MJPEG Third stream: H.265/H.264
Video Bit Rate	32 Kbps to 16 Mbps
H.264 Type	Baseline Profile/Main Profile/High Profile
H.265 Type	Main Profile
Bit Rate Control	CBR/VBR
Scalable Video Coding (SVC)	H.264 and H.265 encoding
Region of Interest (ROI)	1 fixed region for main stream and sub-stream
Audio	
Environment Noise Filtering	Yes
Audio Sampling Rate	8 kHz/16 kHz/32 kHz/44.1 kHz/48 kHz
Audio Compression	G.711ulaw/G.711alaw/G.722.1/G.726/MP2L2/PCM/MP3/AAC

Audio Bit Rate	64 Kbps (G.711ulaw/G.711alaw)/16 Kbps (G.722.1)/16 Kbps (G.726)/32 to 192 Kbps (MP2L2)/8 to 320 Kbps (MP3)/16 to 64 Kbps (AAC)
<b>Network</b>	
Simultaneous Live View	Up to 6 channels
API	Open Network Video Interface (Profile S, Profile G, Profile T), ISAPI, SDK , ISUP
Protocols	TCP/IP, ICMP, HTTP, HTTPS, FTP, DHCP, DNS, DDNS, RTP, RTSP, NTP, UPnP, SMTP, IGMP, 802.1X, QoS, IPv4, IPv6, UDP, Bonjour, SSL/TLS, PPPoE, SNMP
User/Host	Up to 32 users. 3 user levels: administrator, operator and user
Security	Password protection, complicated password, HTTPS encryption, IP address filter, Security Audit Log, basic and digest authentication for HTTP/HTTPS, TLS 1.1/1.2, WSSE and digest authentication for Open Network Video Interface
Network Storage	NAS (NFS, SMB/CIFS), auto network replenishment (ANR)
Web Browser	Plug-in required live view: IE 10, IE 11 Plug-in free live view : Chrome 57.0+, Firefox 52.0+ Local service: Chrome 57.0+, Firefox 52.0+
<b>Image</b>	
Wide Dynamic Range (WDR)	130 dB
Privacy Mask	8 programmable polygon privacy masks, mask color or mosaic configurable
Day/Night Switch	Day, Night, Auto, Schedule
Image Enhancement	BLC, HLC, 3D DNR
Image Parameters Switch	Yes
Image Settings	Rotate mode, saturation, brightness, contrast, sharpness, gain, white balance adjustable by client software or web browser
<b>Interface</b>	
Ethernet Interface	1 RJ45 10 M/100 M self-adaptive Ethernet port
On-Board Storage	Built-in memory card slot, support microSD/SDHC/SDXC/TF card, up to 256 GB
Built-in Microphone	Yes
<b>Event</b>	
Basic Event	Motion detection (support alarm triggering by specified target types (human and vehicle)), video tampering alarm, exception (network disconnected, IP address conflict, illegal login, HDD full, HDD error)
Smart Event	Line crossing detection, intrusion detection, region entrance detection, region exiting detection (support alarm triggering by specified target types (human and vehicle)) Scene change detection
Linkage	Upload toNAS/memory card/FTP, notify surveillance center, trigger record, trigger capture, send email
<b>Deep Learning Function</b>	
Face Capture	Yes
<b>General</b>	
Power	12 VDC, 0.46 A, max. 5.5 W PoE: 802.3af, 36 V to 57 V, 0.18 A to 0.11 A, max. 6.5 W
Material	Cover: metal, main body: metal
Dimension	Ø138.3 mm × 120.1 mm (Ø5.4" × 4.7")
Package Dimension	170 mm × 170 mm × 150 mm (6.7" × 6.7" × 5.9")
Weight	Approx. 870 g (1.9 lb.)

With Package Weight	Approx. 1160 g (2.6 lb.)
Storage Conditions	-30 °C to 60 °C (-22 °F to 140 °F). Humidity 95% or less (non-condensing)
Startup and Operating Conditions	-30 °C to 60 °C (-22 °F to 140 °F). Humidity 95% or less (non-condensing)
Language	33 languages English, Russian, Estonian, Bulgarian, Hungarian, Greek, German, Italian, Czech, Slovak, French, Polish, Dutch, Portuguese, Spanish, Romanian, Danish, Swedish, Norwegian, Finnish, Croatian, Slovenian, Serbian, Turkish, Korean, Traditional Chinese, Thai, Vietnamese, Japanese, Latvian, Lithuanian, Portuguese (Brazil), Ukrainian
General Function	Anti-flicker, heartbeat, mirror, password reset via e-mail, pixel counter
Software Reset	Yes
<b>Approval</b>	
EMC	FCC (47 CFR Part 15, Subpart B) CE-EMC (EN 55032: 2015, EN 61000-3-2: 2019, EN 61000-3-3: 2013+A1: 2019, EN 50130-4: 2011+A1: 2014) RCM (AS/NZS CISPR 32: 2015) IC (ICES-003: Issue 7) KC (KN32: 2015, KN35: 2015)
Safety	UL (UL 62368-1) CB (IEC 62368-1: 2014+A11) CE-LVD (EN 62368-1: 2014/A11: 2017)
Environment	CE-RoHS (2011/65/EU) WEEE (2012/19/EU) Reach (Regulation (EC) No 1907/2006)
Protection	IP67 (IEC 60529-2013)

## Dimension



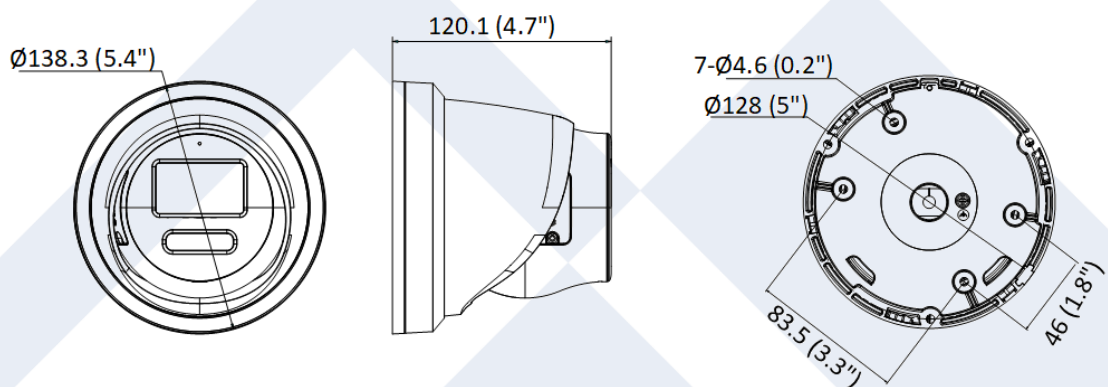







Model With Mic



Unit: mm (inch)

▪ **Accessory**

▪ **Optional**

LTB342-140B Wall Mount	LTB342-140 Wall Mount	LTB378 Vertical Pole Mount	LTB701-A Junction Box	LTB379 Corner Mount
				
				
<b>LTB341</b> <b>Pendant Mount</b>				
